



Pagoda

008.001.006.001

DS008.001.006-v01 (2016-09)



blue rabbit

© 2016

Blue Rabbit 2.0 - Hemelrijken 8 - B-2890 St-Amands - Belgium.
Copyrighted material - Do not reproduce under penalty of law.

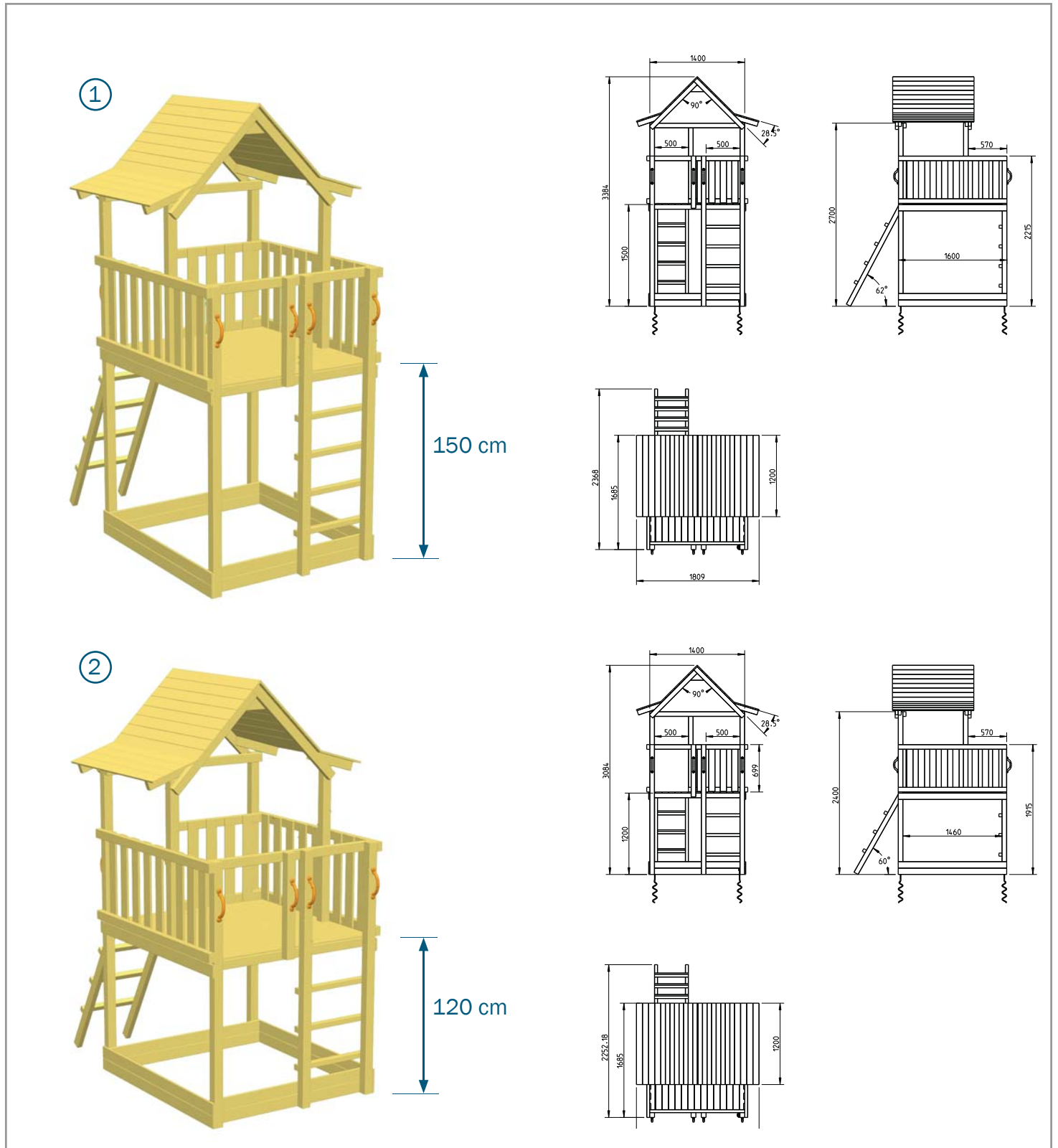

Pagoda

008.001.006.001

blue rabbit 2.0

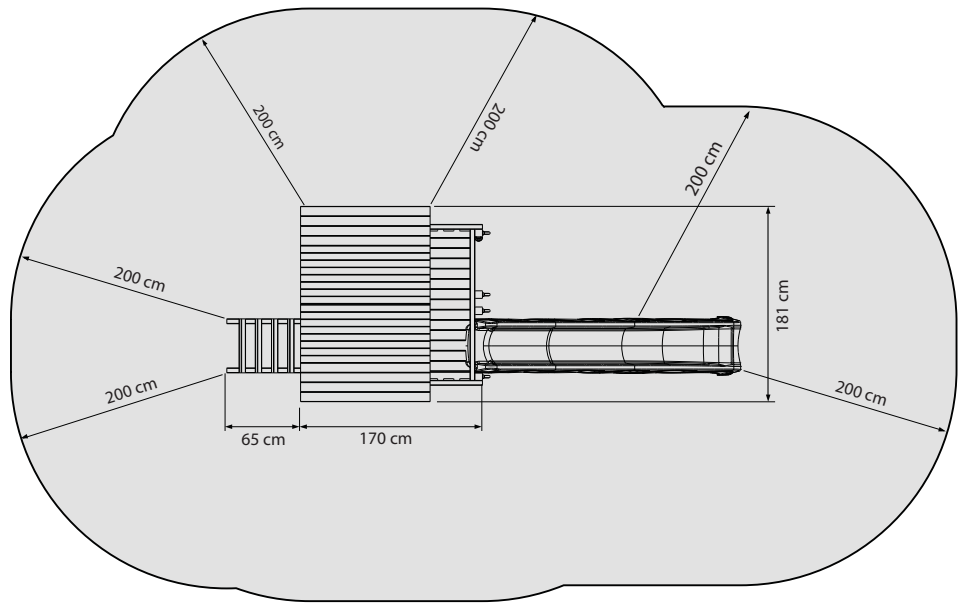
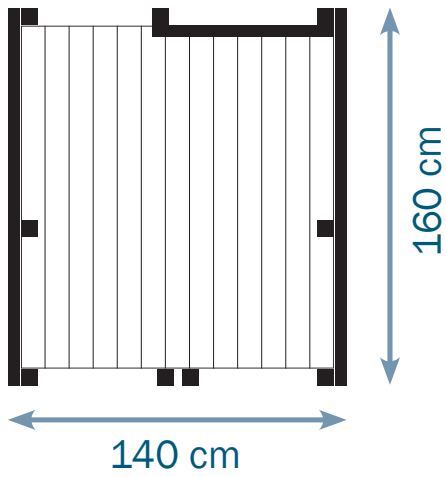

						@ramp 008.003.002.001	@challenger 008.003.007.001
		@platform 008.003.006.001	@net 008.003.003.001	@bridge 008.003.004.001	@steps 008.003.008.001	@wall 008.003.001.001	@swing 008.003.005.001
Pagoda 008.001.006.001		X	⊘ ⊙	⊘ ⊙	⊘ ⊙	⊘ ⊙	⊘ ⊙
	150 cm	X	⊘ ⊙	⊘ ⊙	⊘ ⊙	⊘ ⊙	⊘ ⊙
	120 cm	⊘ ⊙	X	⊘ ⊙	X	X	X

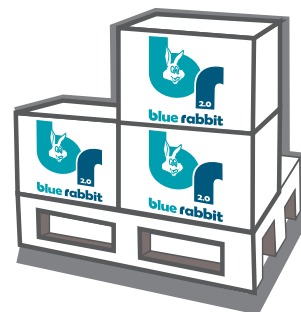

53 x 28 x 11 cm



6,3 kg

?.x



78









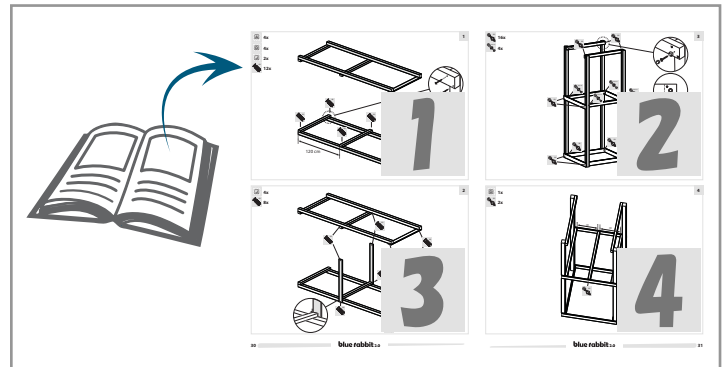
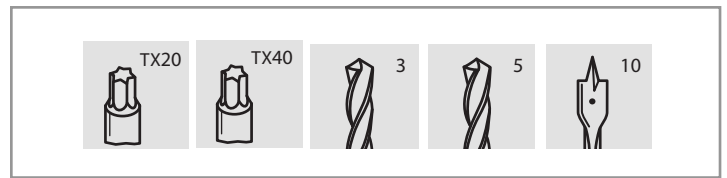
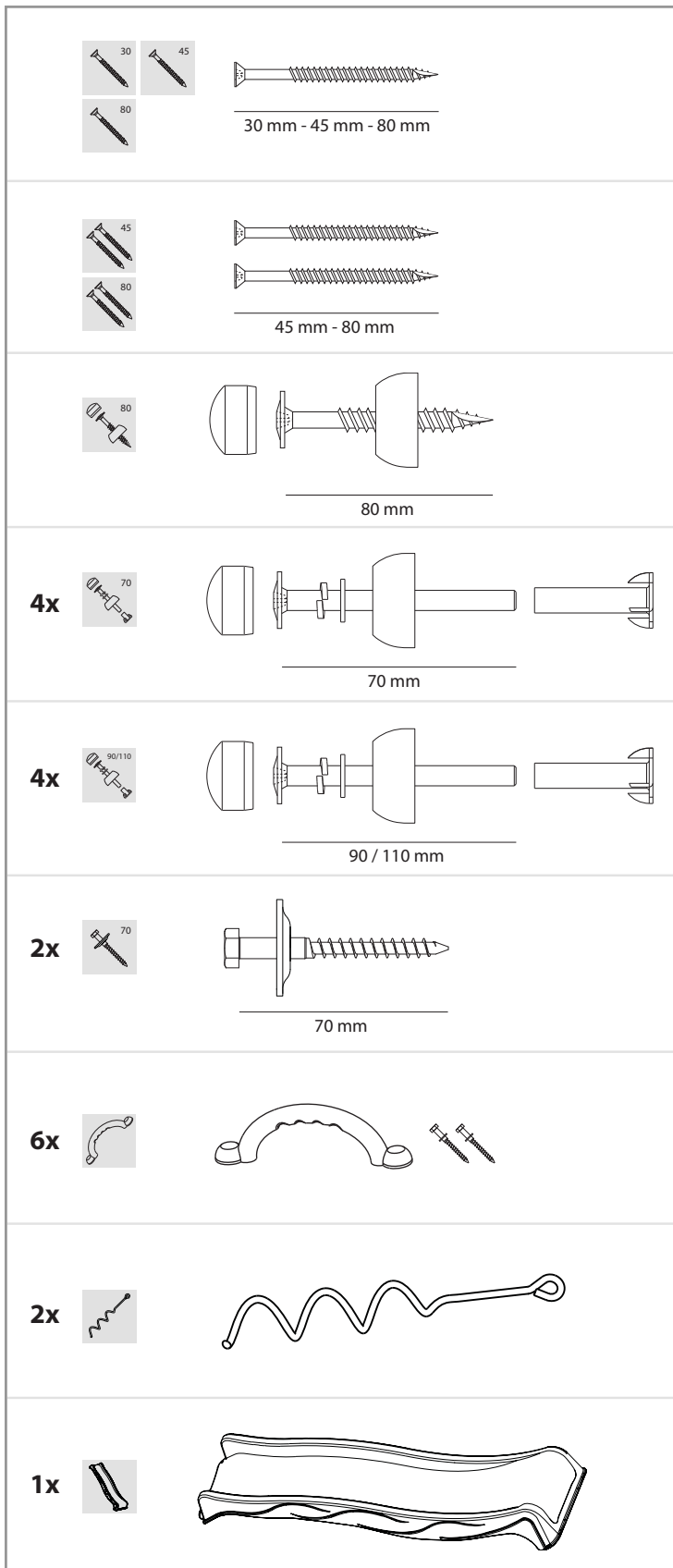

















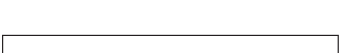













120 x 80 x 158 cm

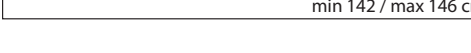

516 kg



- 2x** **A** min 68 mm | max 90 mm  
 - min 68 mm
 - max 90 mm
- 3x** **B** min 68 mm | max 90 mm  
 - min 68 mm
 - max 90 mm
- 1x** **C** min 68 mm | max 90 mm  
 - min 68 mm
 - max 90 mm
- 2x** **D** min 68 mm | max 90 mm  
 - min 68 mm
 - max 90 mm
- 1x** **E** min 68 mm | max 90 mm  
 - min 68 mm
 - max 90 mm
- 2x** **F** min 68 mm | max 90 mm  
 - min 32 mm
 - max 50 mm
- 4x** **G** min 68 mm | max 90 mm  
 - min 32 mm
 - max 50 mm
- 5x** **H** min 68 mm | max 90 mm  
 - min 32 mm
 - max 50 mm
- 2x** **I** min 68 mm | max 90 mm  
 - min 32 mm
 - max 50 mm
- 2x** **J** min 68 mm | max 90 mm  
 - min 32 mm
 - max 50 mm
- 2x** **K** min 68 mm | max 90 mm  
 - min 32 mm
 - max 50 mm
- 4x** **L** min 68 mm | max 90 mm  
 - min 32 mm
 - max 50 mm
- 3x 4x** **M** min 44 mm | max 45 mm  
 - min 44 mm
 - max 45 mm
- 3x 4x** **N** min 44 mm | max 45 mm  
 - min 44 mm
 - max 45 mm
- 6x** **O** min 95 mm | max 145 mm  
 - min 15 mm
 - max 22 mm
- 10x*/15x**** **P** ** min 95 mm | * max 145 mm  
 - min 15 mm
 - max 22 mm
- 4x** **Q** min 95 mm | max 145 mm  
 - min 15 mm
 - max 22 mm
- 16x*/24x**** **R** ** min 95 mm | * max 145 mm  
 - min 15 mm
 - max 22 mm
- 15x*/20x**** **S** ** min 95 mm | * max 145 mm  
 - min 15 mm
 - max 22 mm
- 2x** **T** min 95 mm | max 145 mm  
 - min 15 mm
 - max 22 mm

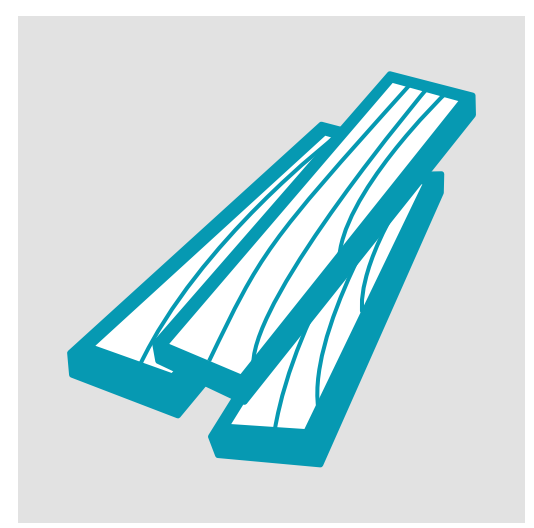
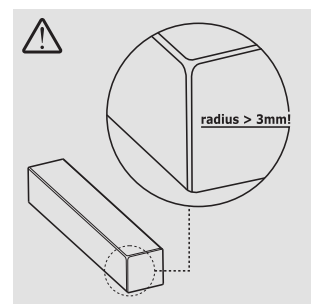
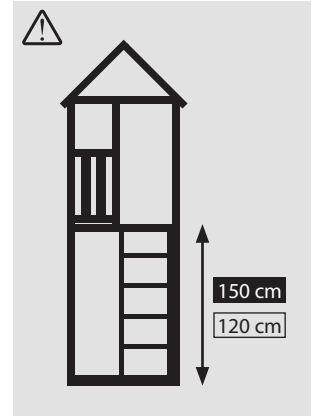



Blue Rabbit 2.0®
Hemelrijken 8
B-2890 Sint-Amands
BELGIUM

info@bluerabbit.be

www.bluerabbit.be